

POPIS PRODUKTU

- Možnost přizpůsobit úhel mezi profily
- Jednoduchá montáž
- Dobrá stabilizace profilových spojů
- Možnost sestavení svítidel o různých tvarech

Vyplňte prázdná pole

Číslo produktu

Typ
příslušenství

Firma

Projekt

Datum



TECHNICKÁ SPECIFIKACE

Účel produktu

- ke spojování rovných a úhlových profilů KLUŠ vybavených „malým zámkem“ a ke stabilizaci koncovek profilů montovaných v řadě

Instalace

- pomocí utahovacích šroubů

Další informace

- plech z nerezové oceli, tloušťka 1.5 mm
- pokud je úhel mezi spojovanými svítidly jiný než nominální, můžeme jej ohnout do požadované hodnoty 5 stupňů na jednu stranu

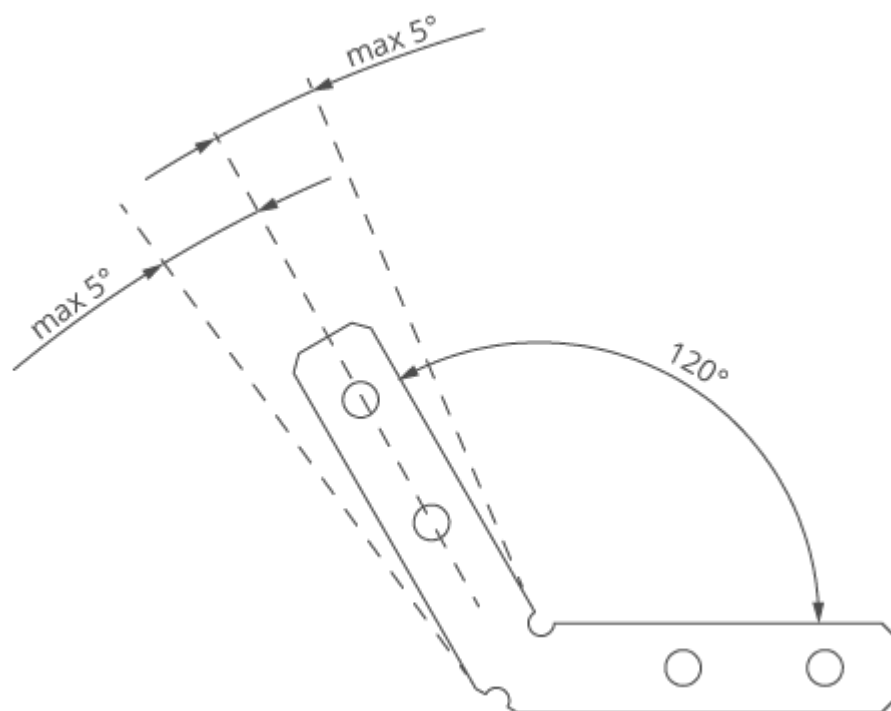

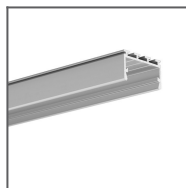
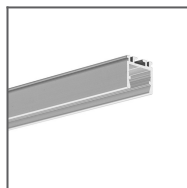
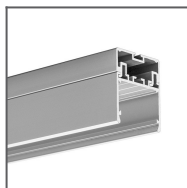
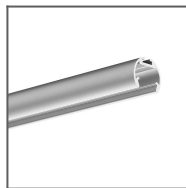
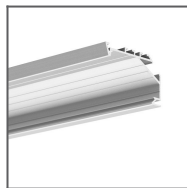
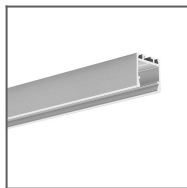
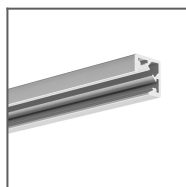
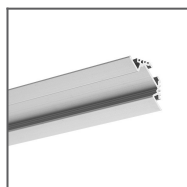
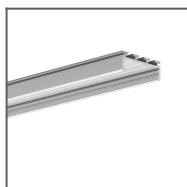
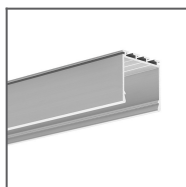
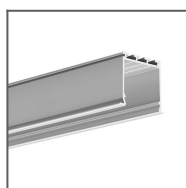
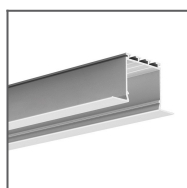
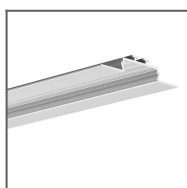
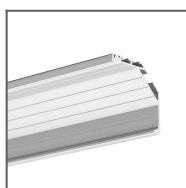
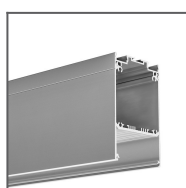
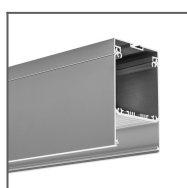
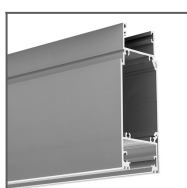
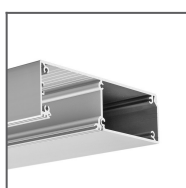
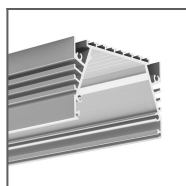
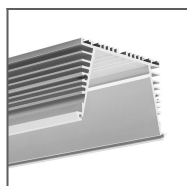
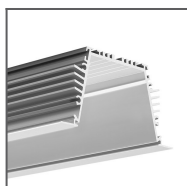
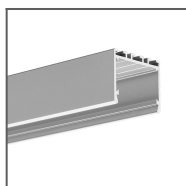
SOUVISEJÍCÍ PROFILYProfil GIZA-LL
Ref: C0758Profil OPK-4
Ref: C0370Profil 3035
Ref: 18039Profil JAZ
Ref: B8547Profil OLEK
Ref: B8505Profil KOPRO-30
Ref: B7890Profil PDS-ZM
Ref: B7696Profil GLAD-45
Ref: B7009Profil KUBIK-45
Ref: B7697Profil PAC-ALU
Ref: B4370Profil GIZA
Ref: B5556Profil LIPOD
Ref: B5554Profil LOKOM
Ref: B5553Profil LARKO
Ref: B5552Profil OPAC-30
Ref: B6164Profil KOPRO
Ref: B6367Profil DES
Ref: 18030Profil GLADES
Ref: 18036Profil KIDES-DUO
Ref: 18032Profil KIDES
Ref: 18031Profil SEPOD
Ref: B6593Profil SEKOMA
Ref: B6595Profil SEKODU
Ref: B6597Profil 3035-O
Ref: B8441

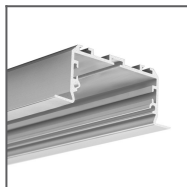

Profil LARKO-50
Ref: C0756

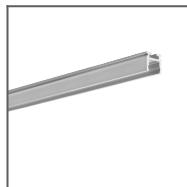

Profil PIKO-ZM
Ref: C1168

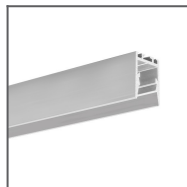

Profil PDS-ZMG
Ref: C1418

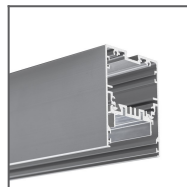

Profil MOD-50
Ref: 18047

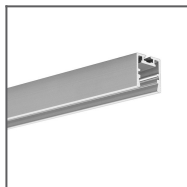

Profil PDS-ZM-PLUS
Ref: C2056

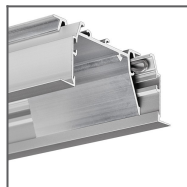

Profil RAM-KOL-50
Ref: 18060

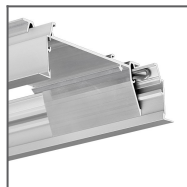

Profil RAM-KOL-100
Ref: 18062

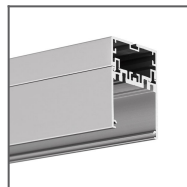

Profil 4050
Ref: 18050

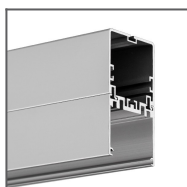

Profil 4050-W
Ref: 18051



Profil GIZA-DUO-LL
Ref: C2162

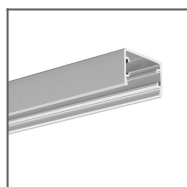

Profil GLAZA-LL
Ref: C2627